

L10 - 16 Mixer Dimensions

L10 Mixer 16 Channel
Top View

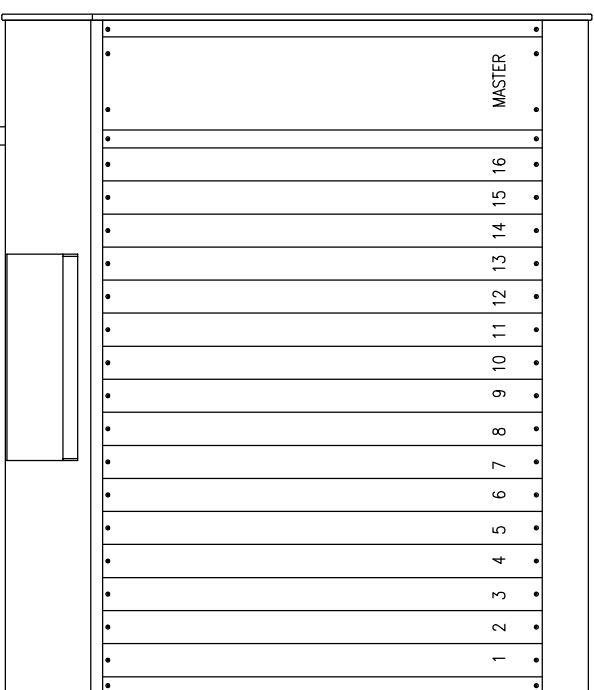

Order number: LA-16-VU1-xx-PSS-3A-xxx-OPT2-PEDN

Output Transformers

- T0 - No transformers
- T1 - Mix outputs only (standard)
- T2 - Group outputs only
- T3 - Mix and group outputs

Power Supply Mains Voltage

- 100 - 100V/AC 50/60Hz
- 120 - 120V/AC 50/60Hz
- 220 - 220V/AC 50/60Hz
- 230 - 230/240V/AC 50/60Hz

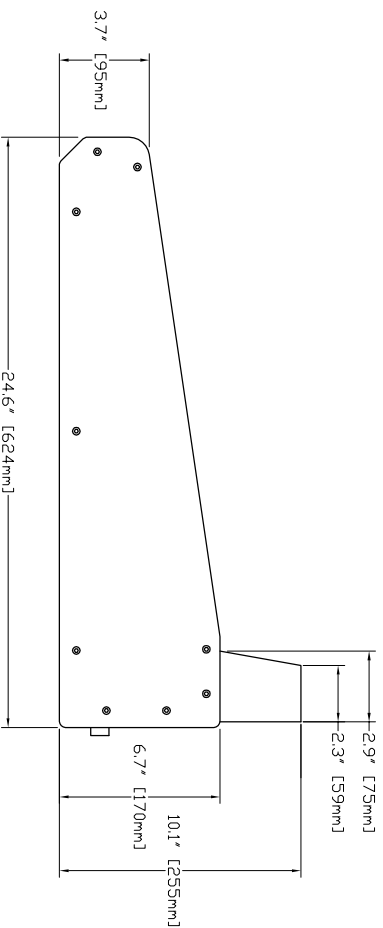

L10 Mixer 16 Channel
Side View

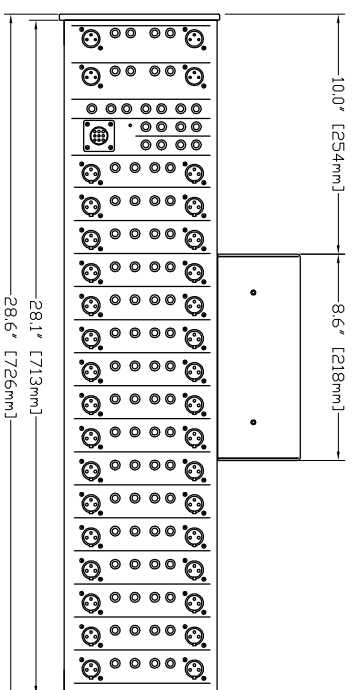

L10 Mixer 16 Channel
Rear View

Lilo - 16 Mixer Dimensions

Shown with optional mixer stand

Order number: LA16-VU1-xx-PS5-3A-xxx-OPT2-PED16

Output Transformers

- T0 - No transformers
- T1 - Mix outputs only (standard)
- T2 - Group outputs only
- T3 - Mix and group outputs

Power Supply Mains Voltage

- 100 - 100VAC 50/60Hz
- 120 - 120VAC 50/60Hz
- 220 - 220VAC 50/60Hz
- 230 - 230/240VAC 50/60Hz

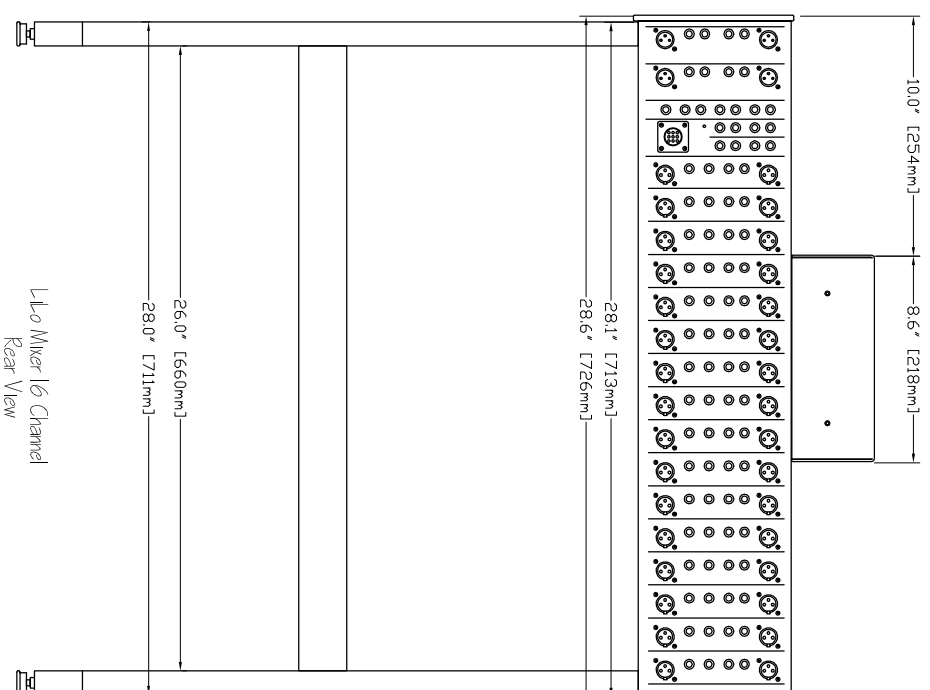
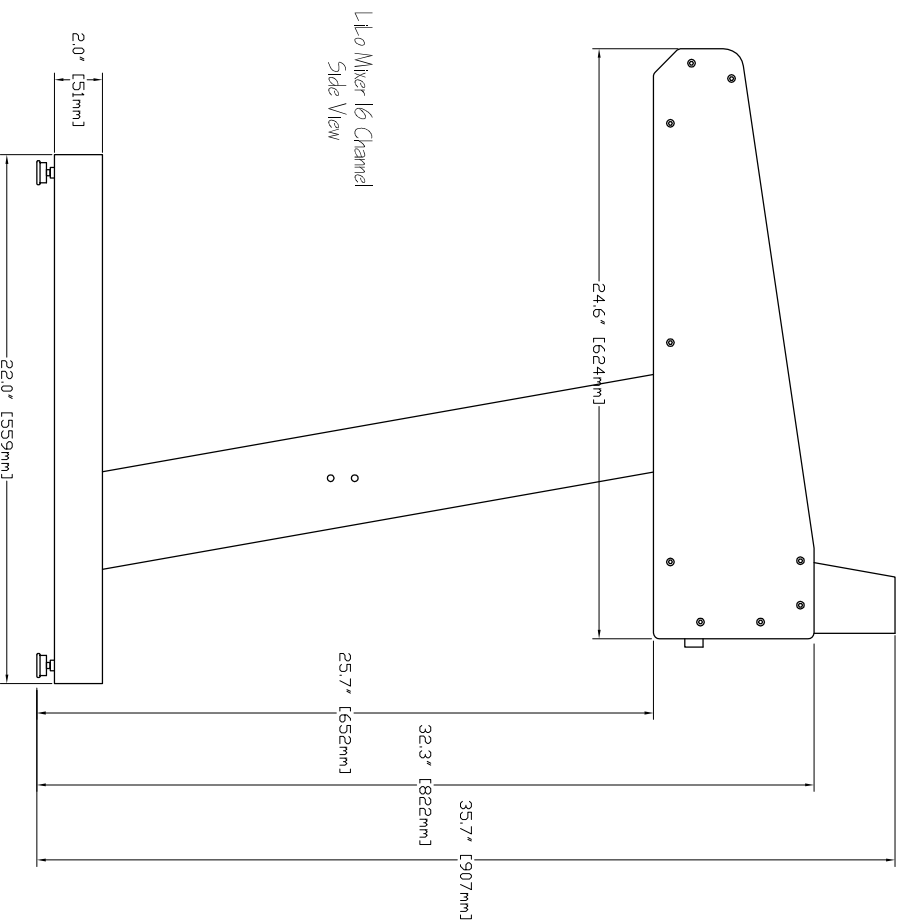

Lilo - 24 Mixer Dimensions

VU meter pod mounted off-center.
 (model number suffix "OPT1")

Lilo Mixer 24 Channel
 Top View

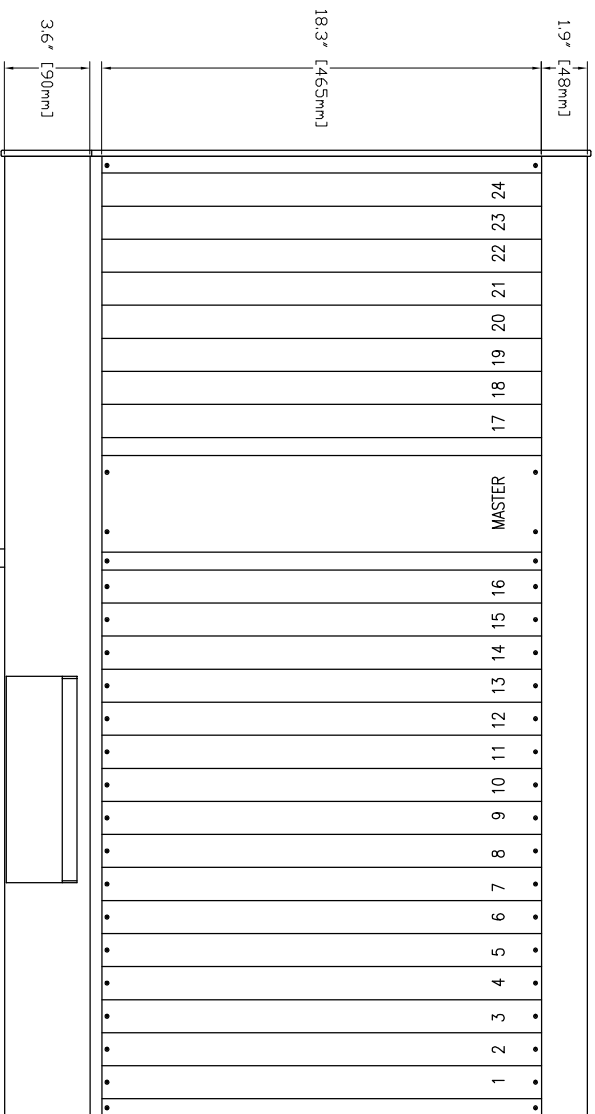

Order number: LB-24-VU1-xx-PSS-5A-xxx-OPT1-PEDN

Output Transformers

- T0 - No transformers
- T1 - Mix outputs only (standard)
- T2 - Group outputs only
- T3 - Mix and group outputs

Power Supply Mains Voltage

- 100 - 100V/AC 50/60Hz
- 120 - 120V/AC 50/60Hz
- 220 - 220V/AC 50/60Hz
- 230 - 230/240V/AC 50/60Hz

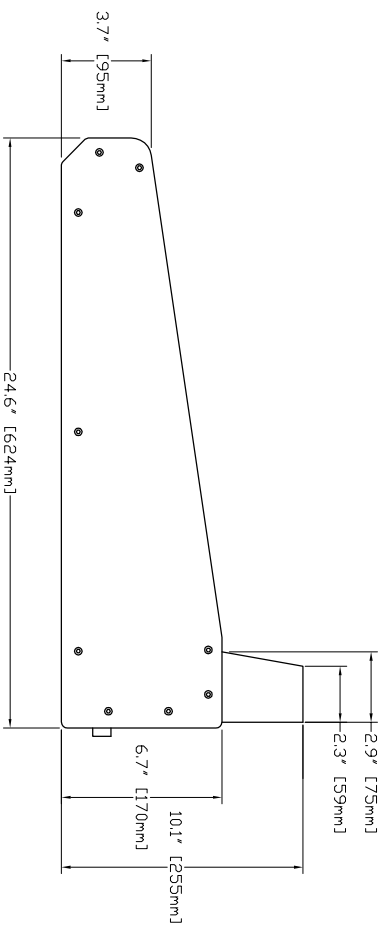

Lilo Mixer 24 Channel
 Side View

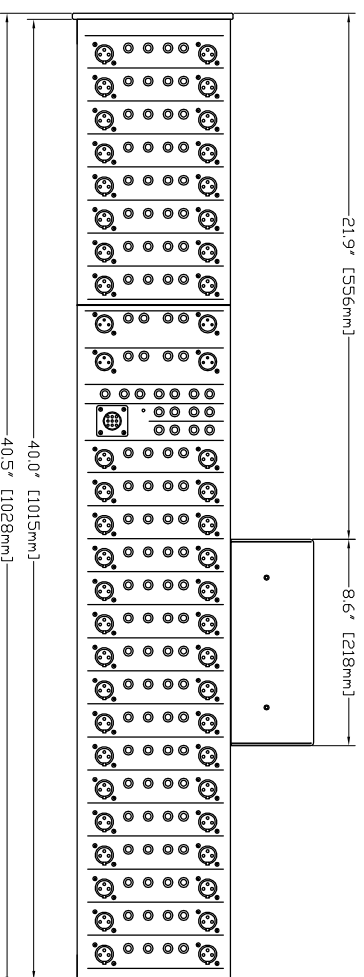

Lilo Mixer 24 Channel
 Rear View

Lilo - 24 Mixer Dimensions

Shown with optional mixer stand

VU meter pod mounted off-center.

(model number suffix "OPT1")

Order number: LB-24-VU1-xx-PS5-5A-xxx-OPT1-PED24

Output Transformers

- T0 - No transformers
- T1 - Mix outputs only (standard)
- T2 - Group outputs only
- T3 - Mix and group outputs

Power Supply Mains Voltage

- 100 - 100VAC 50/60Hz
- 120 - 120VAC 50/60Hz
- 220 - 220VAC 50/60Hz
- 230 - 230/240VAC 50/60Hz

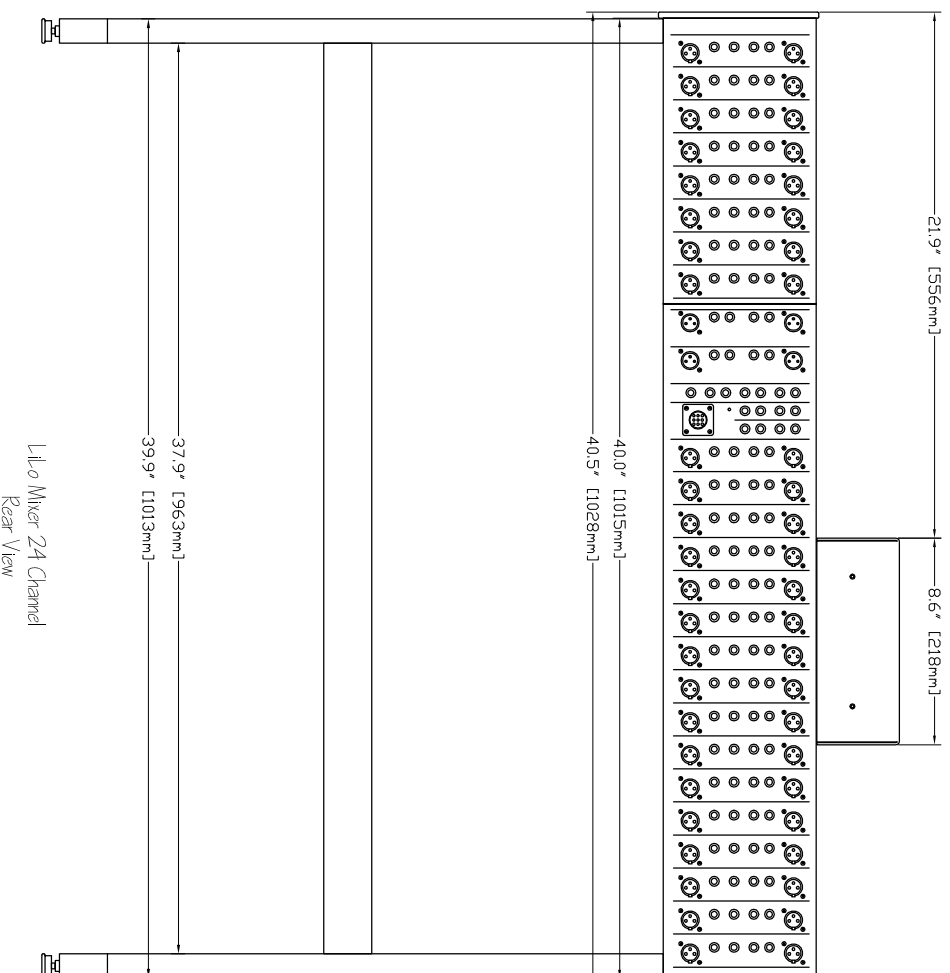
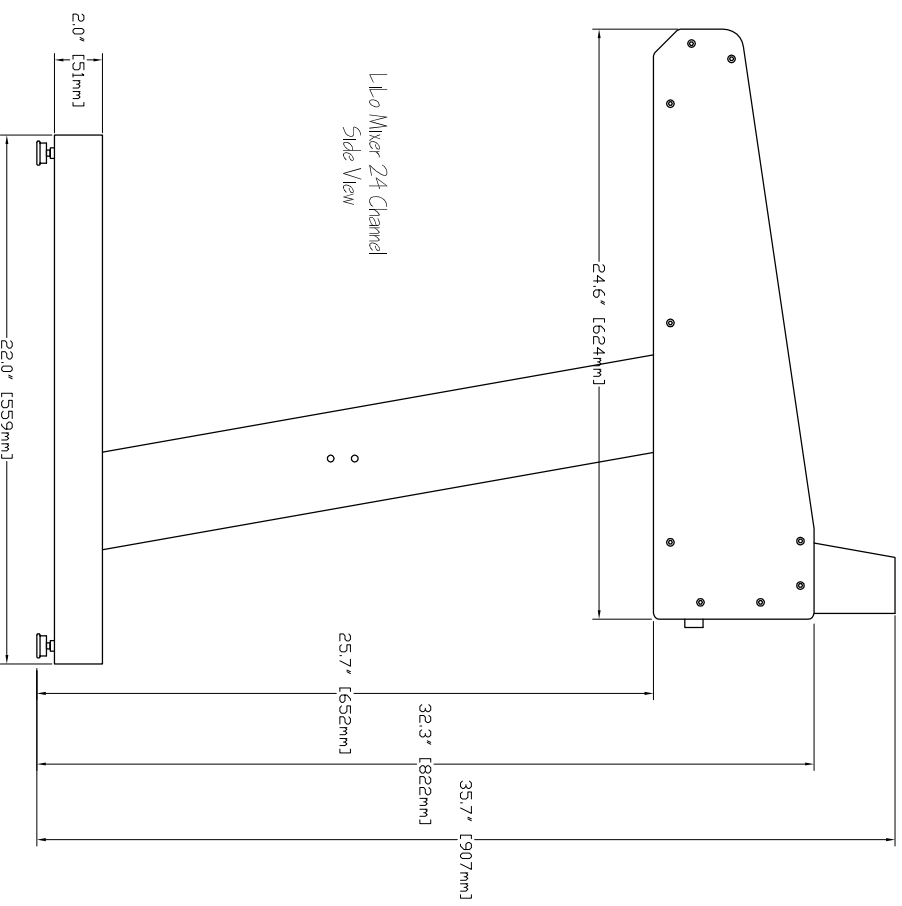

L10 - 24 Mixer Dimensions

VU meter pod mounted in the middle of the frame.
(model number suffix "OPT2")

L10 Mixer 24 Channel
Top View

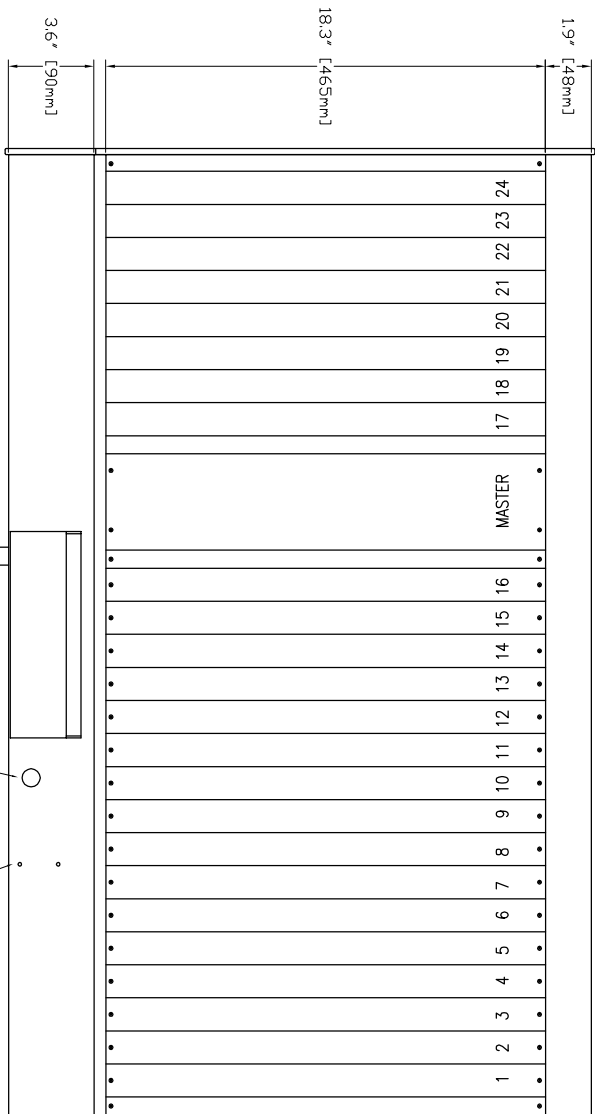

With the VU meter pod mounted in the center position, there is a .75" diameter hole covered with a cap that is painted the same color as the chassis and can be seen on the top surface of the chassis.

With the VU meter pod mounted in the center position, there are two (2) small screws that can be seen on the top surface of the chassis.

Order number: LB-24-VU1-xx-PSS-5A-xxx-OPT2-PEDN

Output Transformers

- T0 - No transformers
- T1 - Mix outputs only (standard)
- T2 - Group outputs only
- T3 - Mix and group outputs

Power Supply Mains Voltage

- 100 - 100V/AC 50/60Hz
- 120 - 120V/AC 50/60Hz
- 220 - 220V/AC 50/60Hz
- 230 - 230/240V/AC 50/60Hz

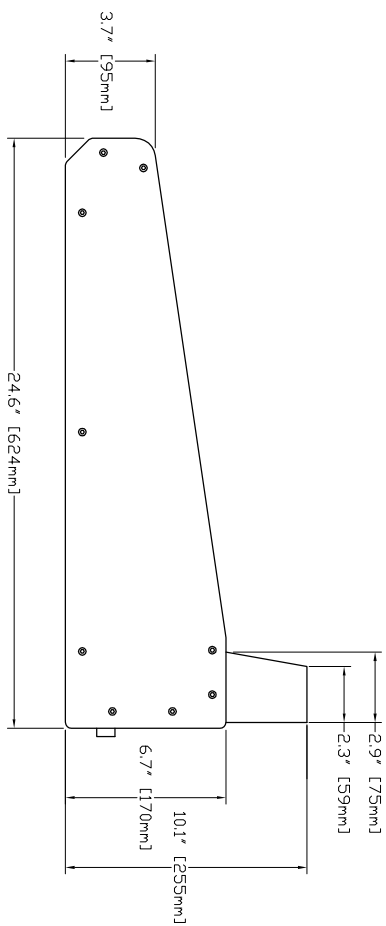

L10 Mixer 24 Channel
Side View

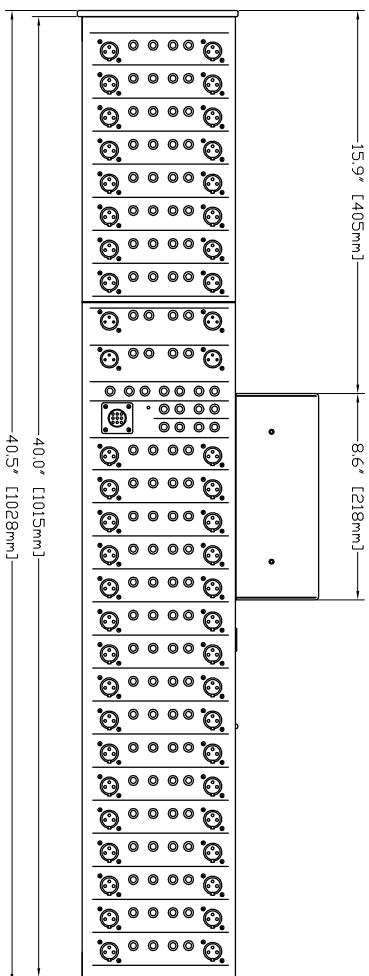

L10 Mixer 24 Channel
Rear View

Lilo - 24 Mixer Dimensions

Shown with optional mixer stand

VU meter pod mounted in the middle of the frame.
(model number suffix "OPT-1")

Order number: LB-24-VU1-xx-PS5-5A-xxx-OPT2-PED24

Output Transformers

- T0 - No transformers
- T1 - Mix outputs only (standard)
- T2 - Group outputs only
- T3 - Mix and group outputs

Power Supply Mains Voltage

- 100 - 100VAC 50/60Hz
- 120 - 120VAC 50/60Hz
- 220 - 220VAC 50/60Hz
- 230 - 230/240VAC 50/60Hz

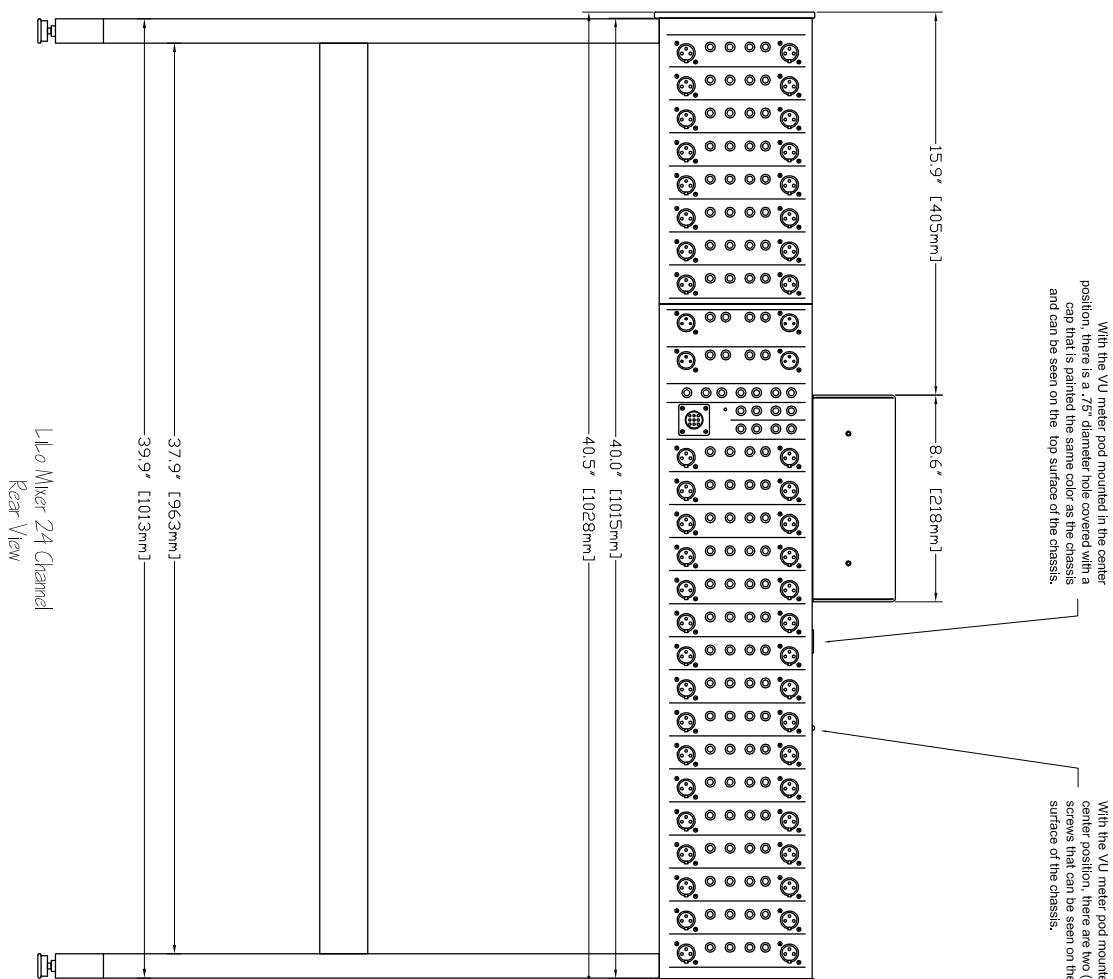
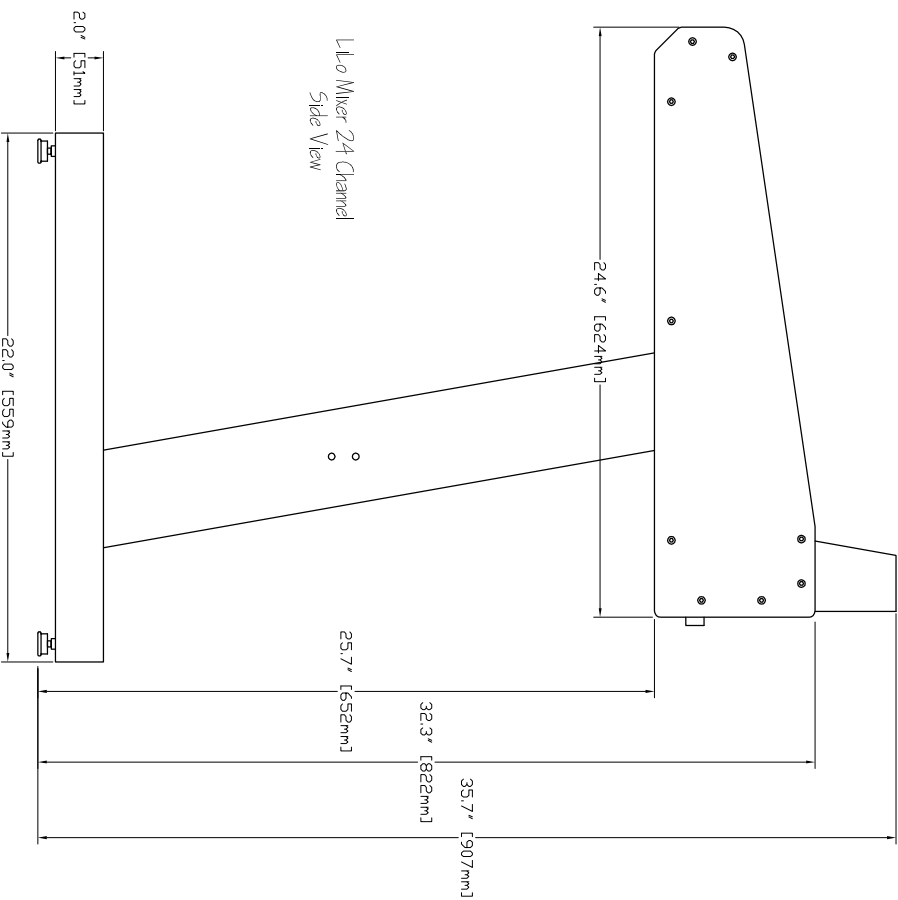
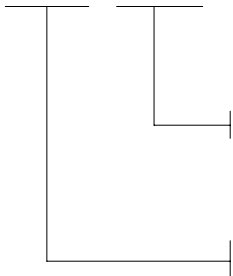

Lilo - 8 Sidecar Dimensions

Order number: LC-8-VU0-T0-PS5-3A-xxx-OPT0-PEDN

Power Supply Mains Voltage
 100 - 100V/AC 50/60Hz
 120 - 120V/AC 50/60Hz
 220 - 220V/AC 50/60Hz
 230 - 230/240V/AC 50/60Hz

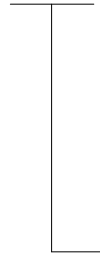

Lilo 8 Channel Sidecar
Top View

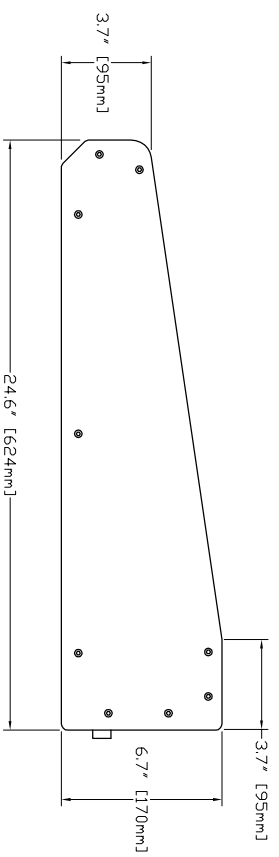
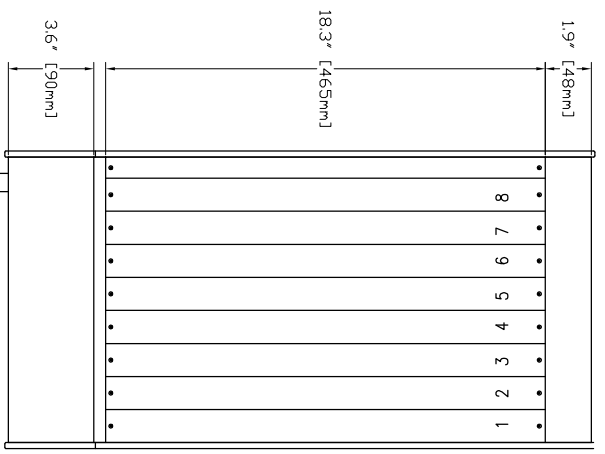

Lilo 8 Channel Sidecar
Side View

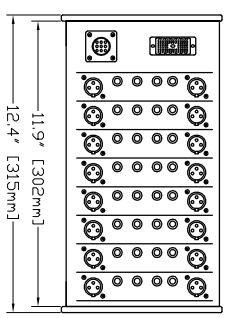

Lilo 8 Channel Sidecar
Rear View

Lilo Power Supply Dimensions

Lilo Power Supply
Bottom View

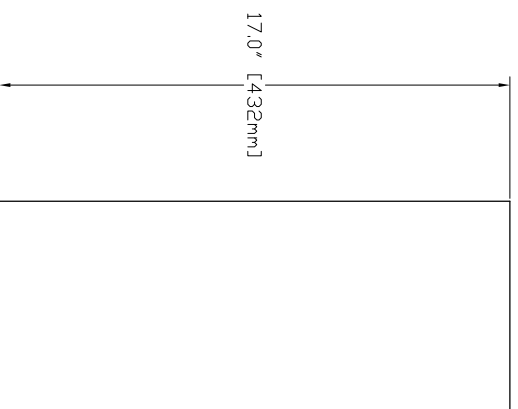

Lilo Power Supply
Side View

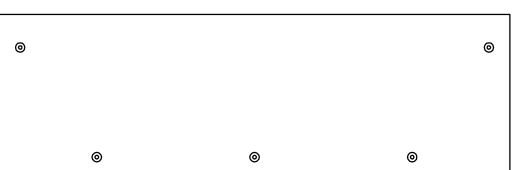

Lilo Power Supply
Side View

